

Data Sheet

WÖHR PARKLIFT 450-3,2

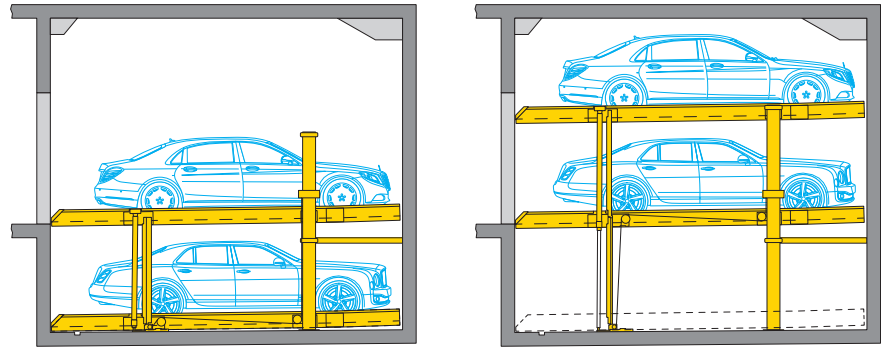

- **Single units: 2 cars**
 - **Platform load options:**
 - max. 3200 kg, load per wheel 800 kg
 - **Platform slopes for drive-on:**
 - upper level: 0,5° = 1% ascent
 - lower level: 0,5° = 1% ascent
- Platform slopes help drainage



■ Length dimensions underground car park (height dimensions see page 2)

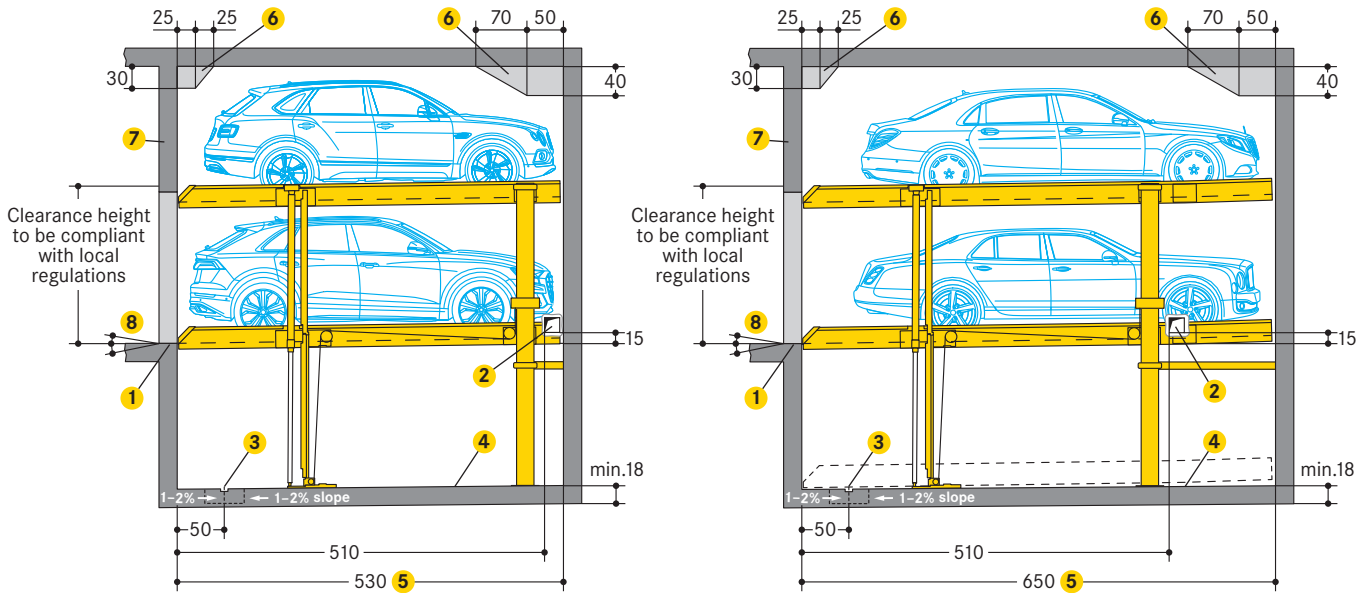

- 1 Yellow-black safety marking (performed by the customer):
 - compliant to ISO 3864, 10 cm wide, along the pit edges (see page 4 »Static calculations and construction works requirements«)
- 2 In case of intermediate walls (performed by the customer):
 - 15 x 15 cm opening for electric and hydraulic system cables and piping
 - after installation, do not close the opening
- 3 Drainage channels (performed by the customer):
 - 10 x 2 cm, with a 50 x 50 x 20 cm drainage pit
 - in case of installation of a sump pump, it is necessary to comply with the drainage pit dimensions specified by the pump manufacturer
 - above-ground garages: if there is a slope on the entrance side, a drainage channel in front of the pit edge is recommended
- 4 Channels or undercuts/concrete haunches (performed by the customer):
 - not allowed along the pit floor-to-wall joints
 - should channels or undercuts be necessary, the system width needs to be reduced or the pit needs to be wider

- 5 500 cm vehicle length = 530 cm pit length
620 cm vehicle length = 650 cm pit length
- 6 Free spaces:
 - please ask WÖHR for the dimension sheets
- 7 Lintel
- 8 Min. 300 cm horizontal and/or max. 3% descent or max. 10% ascent

■ Dimensions

- all dimensions specified are the minimum, finished dimensions
- tolerances must be taken into consideration
- all dimensions are given in cm

Height dimensions Standard type

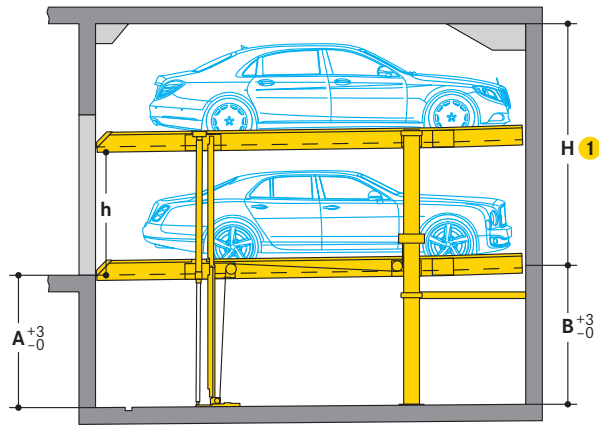

- 1 With an increase in headroom available, correspondingly taller cars will be able to park on the upper platform.
- 2 UL= upper level / LL = lower level
L = Limousine / S = Station wagon

Type	Height (H) 1	Pit depth		Vehicle height 2		Platform distance (h)
		A	B	UL	LL	
450-3,2-170	320	170	165	L+S 150	L+S 150	155
450-3,2-175	325	175	170	L+S 150	L+S 155	160
	330	175	170	L+S 155	L+S 155	160
450-3,2-180	330	180	175	L+S 150	L+S 160	165
	340	180	175	L+S 160	L+S 160	165
450-3,2-185	335	185	180	L+S 150	L+S 165	170
	350	185	180	L+S 165	L+S 165	170
450-3,2-190	340	190	185	L+S 150	L+S 170	175
	360	190	185	L+S 170	L+S 170	175
450-3,2-195	345	195	190	L+S 150	L+S 175	180
	370	195	190	L+S 175	L+S 175	180
450-3,2-200	350	200	195	L+S 150	L+S 180	185
	380	200	195	L+S 180	L+S 180	185

Height dimensions Premium type

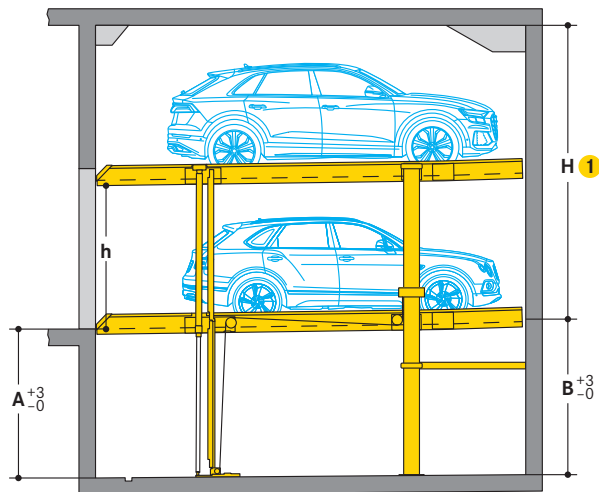

- 1 With an increase in headroom available, correspondingly taller cars will be able to park on the upper platform.
- 2 UL= upper level / LL = lower level
L = Limousine / S = Station wagon

Type	Height (H) 1	Pit depth		Vehicle height 2		Platform distance (h)
		A	B	UL	LL	
450-3,2-205	355	205	200	L+S 150	L+S 185	190
	390	205	200	L+S 185	L+S 185	190
450-3,2-210	360	210	205	L+S 150	L+S 190	195
	400	210	205	L+S 190	L+S 190	195
450-3,2-215	365	215	210	L+S 150	L+S 195	200
	410	215	210	L+S 195	L+S 195	200
450-3,2-220	370	220	215	L+S 150	L+S 200	205
	420	220	215	L+S 200	L+S 200	205
450-3,2-225	375	225	220	L+S 150	L+S 205	210
	430	225	220	L+S 205	L+S 205	210
450-3,2-230	380	230	225	L+S 150	L+S 210	215
	440	230	225	L+S 210	L+S 210	215
450-3,2-235	385	235	230	L+S 150	L+S 215	220
	450	235	230	L+S 215	L+S 215	220
450-3,2-240	390	240	235	L+S 150	L+S 220	225
	460	240	235	L+S 220	L+S 220	225

Clearance profile (for standard vehicles)

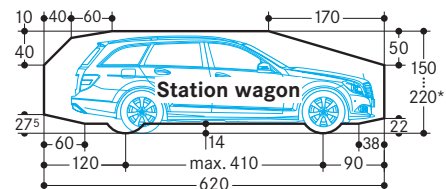
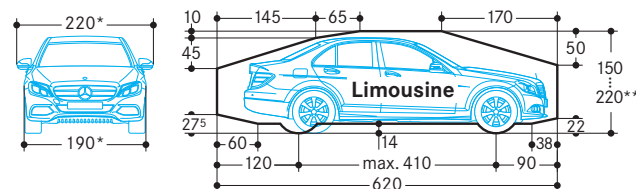

* for a 250 cm platform width
 ** The overall vehicle height including roof luggage rails an antenna mounts must not exceed the max. vehicle height dimensions specified

Width dimensions

Platform widths:

- 250 cm (single units), 500 cm (double units):
 - for 190 cm vehicle width (without outside mirror)
- 260-270 cm (single units), 520-540 cm (double units):
 - for vehicles wider than 190 cm (without outside mirror)
 - for units with intermediate walls
 - for units at the end of the driving aisle

For comfortable parking, entry and exit conditions platform widths upon 250 cm are recommended.

Reduced platform width means reduced parking comfort depending on the vehicle width, vehicle type, individual driving style, access situation of the garage.

Width dimensions (underground car park)

Intermediate walls

Single unit (2 cars)

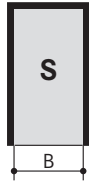

space requirements B	clear platform width
270	240
280	250
290	260
300	270

Row arrangement

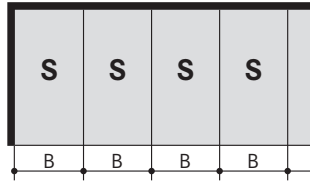

space requirements B	clear platform width
270	240
280	250
290	260
300	270

The driving aisle width must comply with local regulations

It is possible to combine different widths

Columns external to the pit

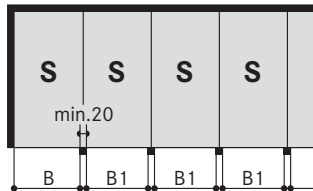

space requirements wall-column B	space requirements wall-column B1	clear platform width
260	250	240
270	260	250
280	270	260
290	280	270

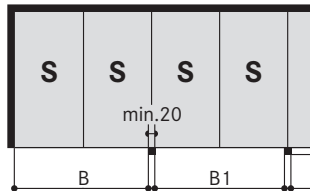

space requirements wall-column B	space requirements wall-column B1	clear platform width
500	490	240+240
520	510	250+250
540	530	260+260
560	550	270+270

The driving aisle width must comply with local regulations

It is possible to combine different widths

Columns in the pit

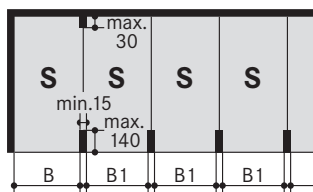

space requirements wall-column B	space requirements wall-column B1	clear platform width
265	255	240
275	265	250
285	275	260
295	285	270

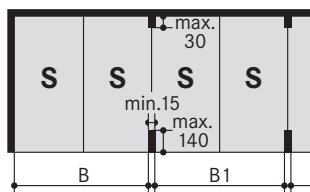

space requirements wall-column B	space requirements wall-column B1	clear platform width
505	495	240+240
525	515	250+250
545	535	260+260
565	555	270+270

The driving aisle width must comply with local regulations

It is possible to combine different widths

Garages with doors

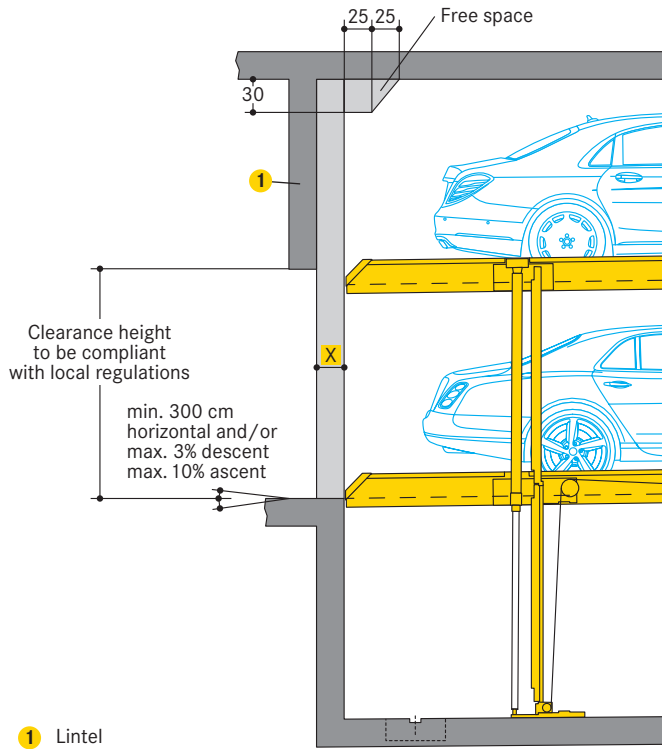

- I** Lintel
 - X** = 10/15 cm for roller shutters
- Dimension X to be defined by customer with the door supplier.

Single unit (2 cars)

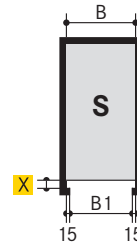

Row arrangement with single doors

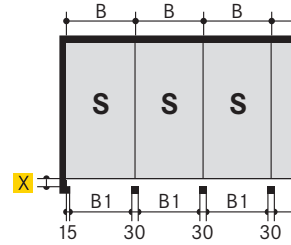

Row arrangement with double doors

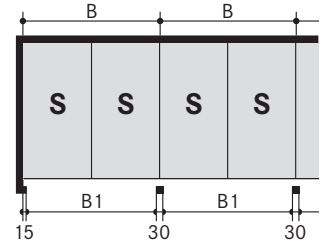

space requirements		clear platform width
B	B1 ²	
270	240	240
280	250	250
290	260	260
300	270	270

space requirements		clear platform width
B	B1 ²	
510	480	240
530	500	250
550	520	260
570	540	270

- 2** B1 = drive-in passage width

Wall recess

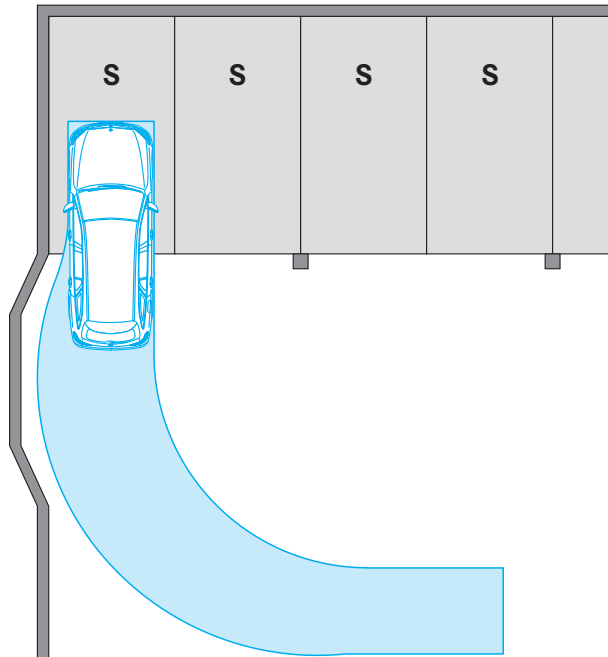

According to GaVo for Baden-Württemberg (07.07.1997/26.01.2011):
 For parking places with a 90° arrangement at the end of the driving aisle, the entrance width must be min. 275 cm.
 At the end of the driving aisle, we recommend to provide a wall recess, if technically possible.

Static calculations and construction works requirement

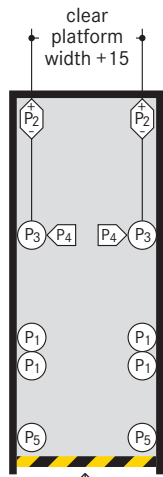

P1	+ 51 kN* - 25 kN
P2	± 4 kN
P3	+ 29 kN
P4	± 1,5 kN
P5	+ 1,5 kN

*specified load bearing data includes the vehicle weight

Safety marking compliant to ISO 3864

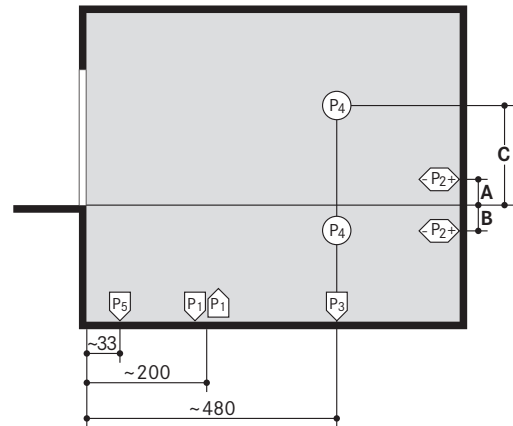

Fixing of the system frames to the floor slab:

- using base plates (approx. 140 cm²)
- using adhesive anchor bolts
- hole depth to 12-14 cm
- concrete thickness of at least 18 cm

Concrete quality grade:

- compliant to the static requirements of the construction
- min. C20/25 grade (for dowel fastening)

Walls:

- front drive-in wall, rear and side walls in concrete
- perfectly flat wall surfaces
- without protruding sections such as border edgings, pipes and tubes, etc.
- concrete thickness of at least 18 cm

Frame bearing points:

- the specified lengths are expressed as mean value
- for the exact data, specific TÜV-tested data sheets are available

Standard type	A	B	C
Parklift 450-3,2-170	-	0	220
Parklift 450-3,2-175	-	5	215
Parklift 450-3,2-180	-	10	210
Parklift 450-3,2-185	-	15	205
Parklift 450-3,2-190	-	20	200
Parklift 450-3,2-195	-	25	195
Parklift 450-3,2-200	-	30	190

Premium type	A	B	C
Parklift 450-3,2-205	20	-	280
Parklift 450-3,2-210	15	-	275
Parklift 450-3,2-215	10	-	270
Parklift 450-3,2-220	5	-	265
Parklift 450-3,2-225	-	0	260
Parklift 450-3,2-230	-	5	255
Parklift 450-3,2-235	-	10	250
Parklift 450-3,2-240	-	15	245

Extra space for hydraulic power packs

Dimensions in cm	1-5 Parklifts	6-10 Parklifts
Length:	100	150
Height:	140	140
Depth:	35	35

Hydraulic power pack placement options:

- located either on the top platform so that it moves with unit or on the wall
- where this is not possible, it is necessary to arrange for an extra space above drive-in level (i.e. for a wall recess or a niche)

Operating panel recesses and empty piping requirements

Flush mounted

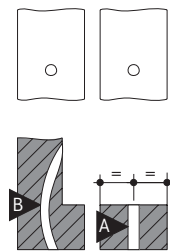

Recess mounted

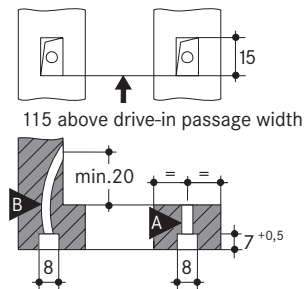

- A** M20 plastic or steel-armoured piping
- B** M20 flexible, plastic-insulated piping

Electrical specifications

Installation diagram

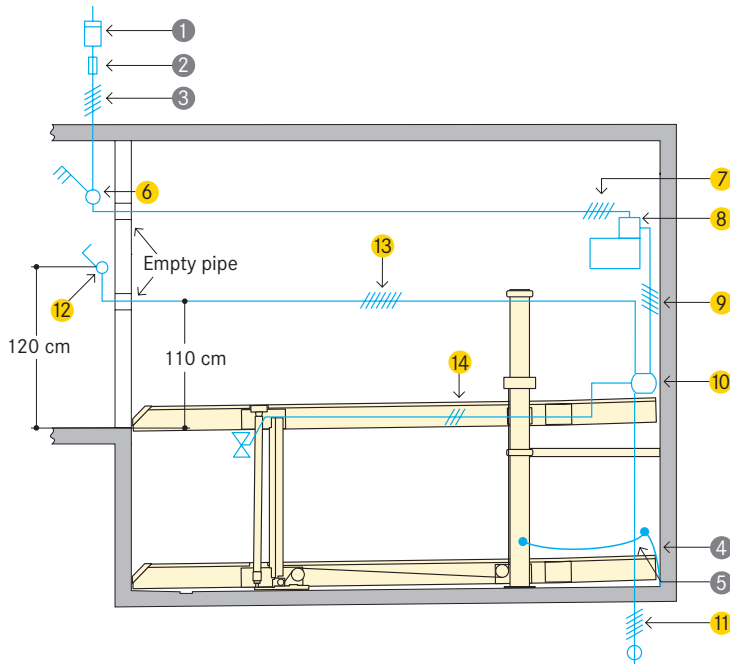

- Cabling preparation to be performed by the customer:
- up to the main switch to be in place prior to starting the installation operations
 - connection to the main switch during installation
 - system functional check testing can be performed by WÖHR together with the electrician provided by the customer
 - if requested at a later date, functional check testing can be performed by WÖHR at extra-cost

Grounding and potential equalisation (to be performed by the customer):

- compliant to DIN EN 60204
- connections required every 10 metres

To be performed by the customer

Item	Quantity	Description	Position	Recurrence
1	1 piece	power meter	in the feed cable	
2	1 piece	fuse protection or automatic circuit breaker compliant to DIN VDE 0100 part 430: - 3 x 16 A slow blow for 3.0 kW power pack (starting current 24 A) only 1 system per power pack - 3 x 25 A slow blow for 5.5 kW power pack (starting current 57 A) several systems per power pack	in the feed cable	1 x per power pack
3	based on site conditions	compliant to local power supply regulations 3 phases + N + PE* 230/400 V, 50 Hz	feed cables to main switch	1 x per power pack
4	every 10 m	grounding and potential equalisation lead-out connection	along pit floor edges/rear wall	
5	1 piece	grounding and potential equalisation compliant to DIN EN 60204	from lead-out connection to system	1 x per system

* to DIN VDE 0100 sections 410 and 430 (no permanent load) 3 phases + N+ PE (three phase current)

Note: for garages with doors the door manufacturer must be consulted before the electrical feed cabling is laid.

Scope of delivery by WÖHR (unless otherwise specified)

Item	Description
6	Lockable main switch
7	5 x 2.5 mm ² PVC control cable leading from the main switch to the 3.0 kW power pack 5 x 4.0 mm ² PVC control cable leading from the main switch to the 5.5 kW power pack
8	Hydraulic power pack with three-phase motor 3.0 kW or 5.5 kW. Ready-wired switching cabinet with motor safety contactor
9	5 x 1.5 mm ² PVC control cable
10	Branch connector
11	5 x 1.5 mm ² PVC control cable lead-out to the system alongside
12	UP/down operating unit with EMERGENCY STOP. Possibly located on the left, but always out of the platform's range of movement. Cable feed-in strictly from below leading upwards (2 keys for each parking space).
13	7 x 1.5 mm ² PVC control cable
14	3 x 1.5 mm ² control cable for the cylinder valve lead

Notes and directions

Scope of application

- suitable for residential buildings, office buildings and business premises, hotels
- only for long-term users that have been instructed on how to use the system
- for frequently changing users (e.g. for office, hotel and business premises or similar):
 - only parking on top platform
 - performance of technical system adjustments is necessary
 - consultation with WÖHR is mandatory

Noise protection

asis is the German DIN 4109 "Noise protection in buildings". With the following conditions required 30 dB (A) in rooms can be provided:

- noise protection package from our accessory
- insulation figure of the construction of min. $R'_w = 57$ dB
- walls which are bordering the parking systems must be done as single wall and deflection resistant with min. $m' = 300$ kg/m²
- solid ceiling above the parking systems with min. $m' = 400$ kg/m²

At differing constructional conditions additional sound absorbing measures are to be provided by the customer.

The best results are reached by separated sole plates from the construction.

Increased sound insulation (separate agreement):

It is based on VDI 4100 „Sound insulation in building construction“ Assessment and proposals for increased sound insulation.

Under the following conditions, 25 dB (A) can be complied with in living spaces and bedrooms:

- sound insulation package according to offer/order
- Sound insulation value of the building structure of min. $R'_w = 62$ dB (to be performed by the customer)

Note:

User noises are not subject to the requirements (see VDI 4100, Scope - Notes). User noises are basically noises that can be individually influenced by the user of the parking systems (e.g. driving on the platform, closing of vehicle doors, engine and brake noises).

Drainage

Water leaks into the pit:

- in the winter, up to 40 litres of snow water can possibly come with the wheel housings in just one parking process

Drainage channels:

- along the front end sections of the pit
- connecting to a floor drain or drainage pit (50 x 50 x 20 cm)
- with manual emptying out of the drainage pit
- alternatively installation of a pump or drainage channel into the sewerage system, to be performed by the customer

Sideways slope drainage:

- only into a gutter
- not possible in the remaining pit section

Lengthways slope drainage:

- provided according to specified construction dimensions

Environmental safety:

- coating of the pit flooring is recommended
- installation of an oil and/or petrol separator unit between the drainage connection and the main sewerage system is recommended

Temperature

- system operating range: -10° bis +40°C (with unloaded platforms lowering speed is reduced if less than +5° C)
- humidity: 50 % at +40° C
- in the event of changes to system conditions please consult with WÖHR

Declaration of conformity



The parking systems are compliant to:

- EC Machinery Directive 2006/42/EC
- DIN EN 14010

Lighting

- sufficient lighting of the driving aisle and of the parking places must be performed by the customer

Fire safety

- all fire safety requirements and all mandatory equipment (fire extinguisher and fire alarm systems, etc.) must be performed by the customer

Railings

The units need to be provided acc. EN ISO 13857 with safety railings if the gap between unit and wall exceeds 20cm. If walkways are arranged directly to the side or behind the systems, railings have to be provided by client acc. to local requirements, height min. 200 cm - this is applicable during the construction phase too.

Maintenance

- WÖHR and all the WÖHR partners abroad provide an installation and customer service network
- regular, annual maintenance is provided subject to the stipulation of a maintenance agreement

Prevention of corrosion damage

- all operations listed in the WÖHR Cleaning and Maintenance Instructions are to be performed regularly (independently of maintenance operations)
- zinc-plated parts, components and platforms are to be kept clean of dirt, road-salt and any other debris (due to corrosion hazards)
- always keep the garage well ventilated and deaerated



Surface protection

- please consider the information on surface protection!



Tender specification

- please consider the specifications!



Parking Place-Profile

- please consider the product information Parking Place-Profile!



Electromobility

- please consider the product information E-charging!
- depending on the position of the charging point on the electric vehicle, collision points with protruding plugs and charging cables can occur



Construction formalities

- the documentation necessary for construction permit applications is provided by WÖHR on demand

Construction alterations and/or modifications

- the right to construction or model modifications and/or variations is hereby reserved
- the right to any subsequent part modification and/or variation and amendments in procedures and standards due to technical and engineering progresses or due to environmental regulation changes is also hereby reserved